

Specifications

Model#	WSL-PNL6"-12W-XXXXK-ES
Description	6" Round Panel Light
Power	12W
Lumen Efficiency	75lm/w
Voltage Input	120Vac
Lumen output	900lm
Color Temperature	3000K, 4000K, 5000K
CRI	Ra>80
LED Chips	SMD 2835
Power Factor	>0.9
Lens	Frosted
Operating Temp.	-25°C~ 55°C
Certificates	ETL/cETL, ES
warranty	3 years
L70 life span	>50000Hrs
Frame	Aluminum
Dimmable	Yes(Triac)



Order Information

Item Number	Description	Power	Voltage Input	Driver	CCT	Lumen Output	Certificates
WSL-PNL4"-9W-XXXXK-ES	6" Round Panel Light	12W	120Vac	UL Certified	3000K 4000K 5000K	900lm	ETL/cETL , Energy Star

Lux Chart

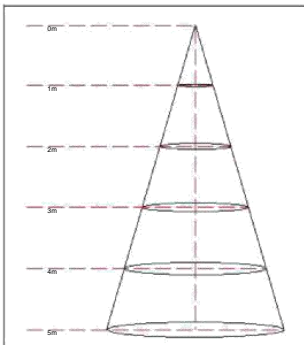

Height	Average Lux (lx)	Light range (dia.)
1M	76.7	277.9cm
2M	19.2	555.9cm
3M	8.5	833.81cm
4M	4.8	1111.7cm
5M	3.1	1389.7cm

Photometrics

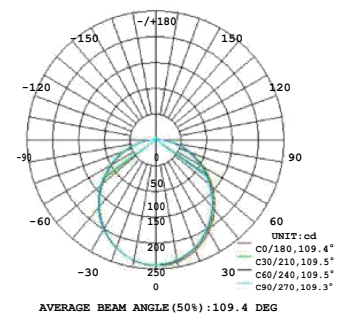

Packaging

32pcs/CTN Dimension:540mm*395mm*340mm

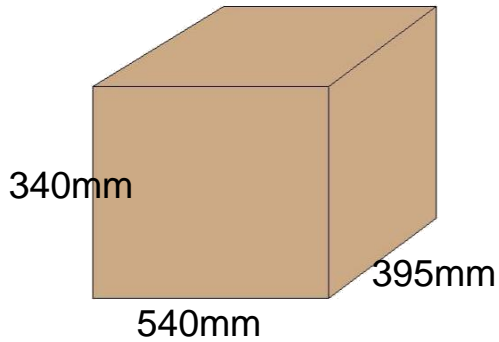

Container Loading QTY

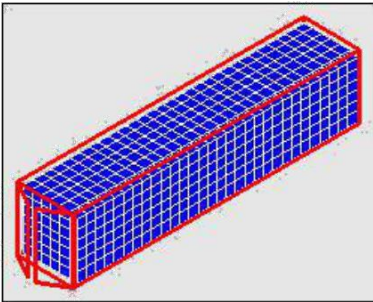

Size	Corton QTY	Product QTY	Volumn
40'hq	1230 ctn	30750 pcs	68.13m ³

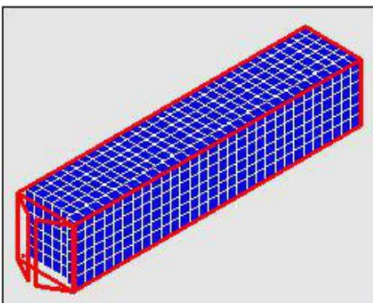

Size	Corton QTY	Product QTY	Volumn
40'gp	1170 ctn	29250 pcs	64.8 m ³

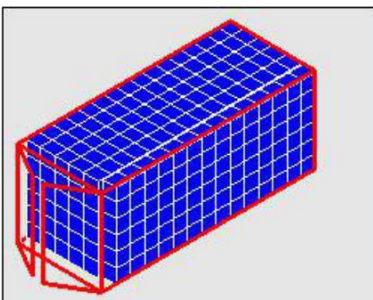

Size	Corton QTY	Product QTY	Volumn
20'gp	564 ctn	14100 pcs	31.24 m ³